

Team

Our largest booth offers flexibility as a meeting space or lounge, allowing larger teams to connect and collaborate.

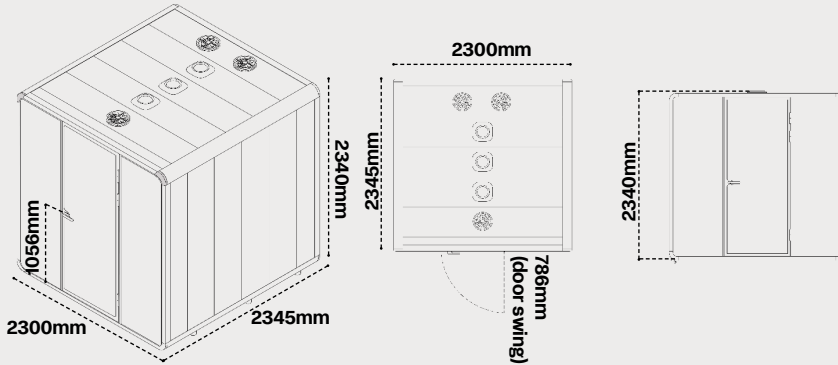

*Dimensions shown are for reference only and do not constitute a technical drawing. A minimum clearance of 40mm is required on all sides for installation and ventilation purposes.

Capacity

4-6 People

Warranty

Two-years warranty

Acoustic

>30db

Footprint

w:2300mm x d:2345mm

Ventilation

- Airflow: 327 m³/hr
- 6x Fans (3x in, 3x out)

Lighting

- 2 Lights: 60w (24V/2.5A)
- Colour temperature: 3000K-6000K (adjustable)
- Colour Rendering Index (CRI): 92
*for individual light

Dimensions (wxdxh)

- Internal: 2162mm x 2315mm x 2146mm
- External: 2300mm x 2345mm x 2340mm
- Doorway: w:741mm x h:2118h
- Weight: 850kg

Control panel

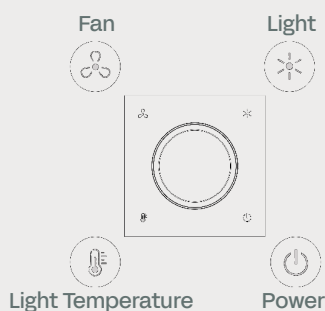

Power and Data

- Outlets: x1 DGPO, x1 USB-C, and x1 USB-A above table height (on wall)
*Additional (Meet Configuration) x1 DGPO, x1 USB-C, x1 USB-A (on table)
- Power access on left side
- Power consumption: 120W
- Motion sensor controls lights and air flow automatically

Design

- Eco-friendly materials and packaging
- Integrated ventilation system
- Fire sprinkler hole: pre-cut opening for easy sprinkler integration
- Built-in occupancy lights
- Control panel: adjust ventilation, light strength, and temperature

Certifications

- UKCA & CE Mark: Independently evaluated by SGS meets UK and EU electrical safety & EMC requirements
- Fire Safety & Flammability: Tested to UK (BS 5852/7176) & EU (EN 13501-1/1021) fire safety standards
- ISO 23351-1 (Acoustics): Lab-measured speech privacy up to ~30dB SLR for quieter calls and focus
- FSC® Chain of Custody (Timber): Responsibly sourced, traceable timber supply
- ISO 9001 / ISO 14001: Certified quality and environmental management systems
- EcoVadis / Cradle to Cradle / EU Ecolabel: Sustainability, lifecycle, and environmental certifications

*Evidence pack available on request; scope may vary by configuration.

Finishes

Exterior Shell

Electrostatic coated / Architectural surface film

- Cloud White Standard
- Domino Black Standard
- Custom Colours

Interior

Fabric Wrap on PET Acoustic Panel

- Focus Range FO-82
- Custom Colours

Carpet

Anti-static

- Dark Grey FP2-1

Occupancy Lighting

- Occupied
- Available

*Any custom finishes will be subject to a 12+ week lead time.

Furniture Configurations

Each booth offers a unique space, the furniture makes it yours. Desks, benches, lean bars, or sofas - every configuration is designed around how people actually work; and what happens inside each booth is up to you.

Most Popular



Team Meet



The Team Meet is designed to inspire productive team collaboration. It comes with two large benches and meeting table, giving your team space to present, decide, and move projects forward.

Finishes

Table

-  Alabaster TB-02
-  Custom Colours

Benches

-  Focus Range FO-86
-  Custom Colours

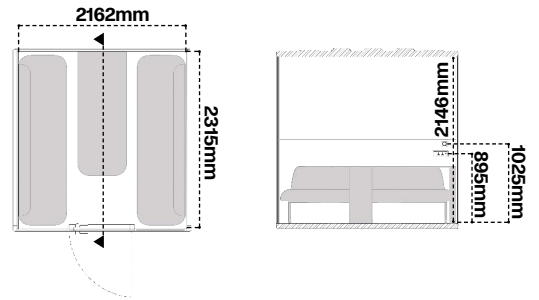

*Dimensions shown are for reference only and do not constitute a technical drawing.



Team Collab



For workshops, brainstorms, and group energy. Team Collab includes a corner sofa and side table with open floor space for movement, notes, and ideas. A flexible room where collaboration stays contained, not chaotic.

Finishes

Tables

-  Alabaster TB-02
-  Custom Colours

Corner Sofa

-  Focus Range FO-86
-  Custom Colours

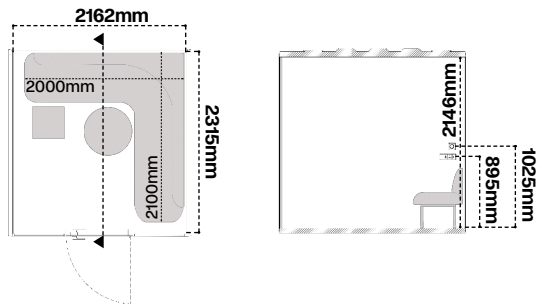

*Dimensions shown are for reference only and do not constitute a technical drawing.



Team Huddle

With space for up to 4 people, seats arranged for quick stand-ups and team check-ins. Team Huddle's central table and ergonomic chairs make alignment fast, focused, and distraction-free, allowing for deeper connection and collaboration.

Finishes

Table

-  Alabaster TB-02
-  Custom Colours

Chairs

-  Black
-  Custom Colours

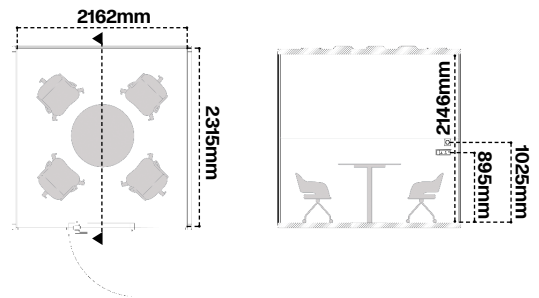

*Dimensions shown are for reference only and do not constitute a technical drawing.



BUREAU

Furnish a workspace that works.

withbureau.com